

# MOUNTING AND INSTRUCTION MANUAL

## DTS 2340.irig-distributor

Please study these instructions carefully before the installation.



### **Certification of the Producer**



### **STANDARDIZATION**

The DTS 2340.irig-distributor was developed and produced in accordance with the EU Guidelines:

2004 / 108 / EG  
96 / 48 / EG

### **References to the Instruction manual**

1. The information in this Instruction manual can be changed at any time without notice. The current version is available for download at [www.mobatime.com](http://www.mobatime.com).
2. This instruction manual has been composed with the utmost care, in order to explain all details in respect of the operation of the product. Should you, however, have any questions or discover any errors in this manual, please contact us.
3. We are not liable for any direct or indirect damages which could occur when using this manual.
4. Please read the instructions carefully and only use the product, after you have correctly understood all the information for installation and operation.
5. It is prohibited to reproduce, store in a computer system, or transfer this publication, or any part of it in any way. The copyright remains with BÜRK MOBATIME GmbH, D-78026 VS-Schwenningen and MOSER-BAER AG – CH 3454 Sumiswald / SWITZERLAND.

# Table of contents

---

1	Safety .....	4
1.1	Safety instructions.....	4
1.2	Symbols and Signal Words used in this Instruction Manual.....	4
1.3	Intended Use .....	4
1.4	Observe operating safety! .....	4
1.5	Consider the installation site!.....	5
1.6	Please observe the electromagnetic compatibility!.....	5
2	Maintenance .....	6
2.1	Troubleshooting: Repairs .....	6
2.2	Cleaning .....	6
2.3	Disposal.....	6
3	General Information: Introduction .....	7
3.1	Scope of Delivery.....	7
3.2	Device Description in this Manual.....	7
3.3	Abbreviations.....	7
3.4	Description of Operation.....	8
3.4.1	Monitoring .....	9
3.4.2	Alarms.....	9
3.4.3	Display .....	9
4	Configuration and Display .....	10
4.1	Status Indicators: Front .....	10
4.2	Signal LEDs: Back .....	10
4.3	Configuration of the IRIG Distributor.....	10
5	Connections.....	11
5.1	Power Supply.....	11
5.2	Input .....	11
5.3	Output.....	11
5.4	Alarm Relay .....	12
5.5	Connection between DTS 4135/4138 and IRIG Distributor .....	12
6	Technical Data.....	13
7	Dimensions of the IRIG Distributor .....	14

# 1 Safety

---

## 1.1 Safety instructions



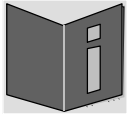

---



Read this chapter and the entire instruction manual carefully and follow all instructions listed. This is your assurance for dependable operations and a long life of the device. Keep this instruction manual in a safe place to have it handy every time you need it.

## 1.2 Symbols and Signal Words used in this Instruction Manual

---

	<b>Danger!</b> Please observe this safety message to avoid electrical shock! There is danger to life!
	<b>Warning!</b> Please observe this safety message to avoid bodily harm and injuries!
	<b>Caution!</b> Please observe this safety message to avoid damages to property and devices!
	<b>Notice!</b> Additional information for the use of the device.

## 1.3 Intended Use

---

The **DTS 2340.irig-distributor** is a signal distributor for IRIG-B 1xx Audio Frequency (AF) and IRIG-B 0xx Digital (D) signals. The distributor contains two equal lines which provide their Audio Frequency and Digital input signal on four outputs each.

For additional functions, see the device descriptions in Chapter 3.4.



**Caution!**

## 1.4 Observe operating safety!

---

- Never open the housing of the device! This could cause an electric short or even a fire, which would damage your device. Do not modify your device!

- The device is not intended for use by persons (including children) with limited physical, sensory, or mental capacities or a lack of experience and/or knowledge.
- Keep packaging such as plastic films away from children. There is the risk of suffocation if misused.



Caution!

### 1.5 Consider the installation site!

---

- To avoid any operating problems, keep the device away from moisture and avoid dust, heat, and direct sunlight. Do not use the device outdoors.
- The device is designed for 19" racks and should only be operated installed in a 19" cabinet.
- By operating the device, the heat sinks attached to the sides get warm. Make sure there is enough air circulation for the heat to dissipate.



#### **Danger! Make sure**

that you wait before using the device after any transport until the device has reached the ambient air temperature. Great fluctuations in temperature or humidity may lead to moisture within the device caused by condensation, which can cause a short.



Caution!

### 1.6 Please observe the electromagnetic compatibility!

---

This device complies with the requirements of the EMC Directive 2004/108/EG and 96/48/EG

## 2 Maintenance

---

### 2.1 Troubleshooting: Repairs

---

If you cannot rectify the problems, contact your supplier from whom you have purchased the device.

Any repairs must be carried out at the manufacturer's plant.

Disconnect the power supply immediately and contact your supplier, if ...

- liquid has entered your device
- the device does not properly work and you cannot rectify this problem yourself.

### 2.2 Cleaning

---

- Please make sure that the device remains clean especially in the area of the connections, the control elements, and the display elements.
- Clean your device with a damp cloth only.
- Do not use solvents, caustic, or gaseous cleaning substances.

### 2.3 Disposal

---



#### Device

At the end of its lifecycle, do not dispose of your device in the regular household rubbish. Return your device to your supplier who will dispose of it correctly.



#### Packaging

Your device is packaged to protect it from damages during transport.

Packaging is made of materials that can be disposed of in an environmentally friendly manner and properly recycled.

## 3 General Information: Introduction

---

### 3.1 Scope of Delivery

---

Please check your delivery for completeness and notify your supplier within 14 days upon receipt of the shipment, if it is incomplete.

The package you received contains:

- DTS 2340.irig-distributor
- 1 pc mounting tool for spring terminals

Optionally available accessories

- adapter BNC for screw-type terminal for connecting two-wire lines to the BNC sockets of the AF outputs.

### 3.2 Device Description in this Manual

---

This manual refers to the **DTS 2340.irig-distributor**. In the following chapters, the terms **IRIG-Distributor** or simply **distributor** will be used in order to increase the readability.

### 3.3 Abbreviations

---

This manual uses the following abbreviations:

- AF      Audio Frequency      amplitude modulated IRIG signal
- D      Digital      IRIG signal without modulation

### 3.4 Description of Operation

The **DTS 2340.irig-distributor** is a signal transmitter for IRIG-B 1xx (AF) and IRIG-B 0xx (D) signals. The transmitter consists of **two identical lines that operate independently of one another**.

Each line has an AF port (BNC connector and spring terminal) and a digital port (spring terminal).

Each of these input signals is converted to **four outlet signals** in the IRIG distributor. The AF signals are transmitted via BNC connectors, and the digital signals are made available through spring terminals.

#### Line 1 and Line 2:

Input: IRIG-B 1xx (AF, modulated)  
IRIG-B 0xx (digital, unmodulated)

Output: 4 x IRIG-B 1xx (AF, modulated)  
4 x IRIG-B 0xx (digital, unmodulated)

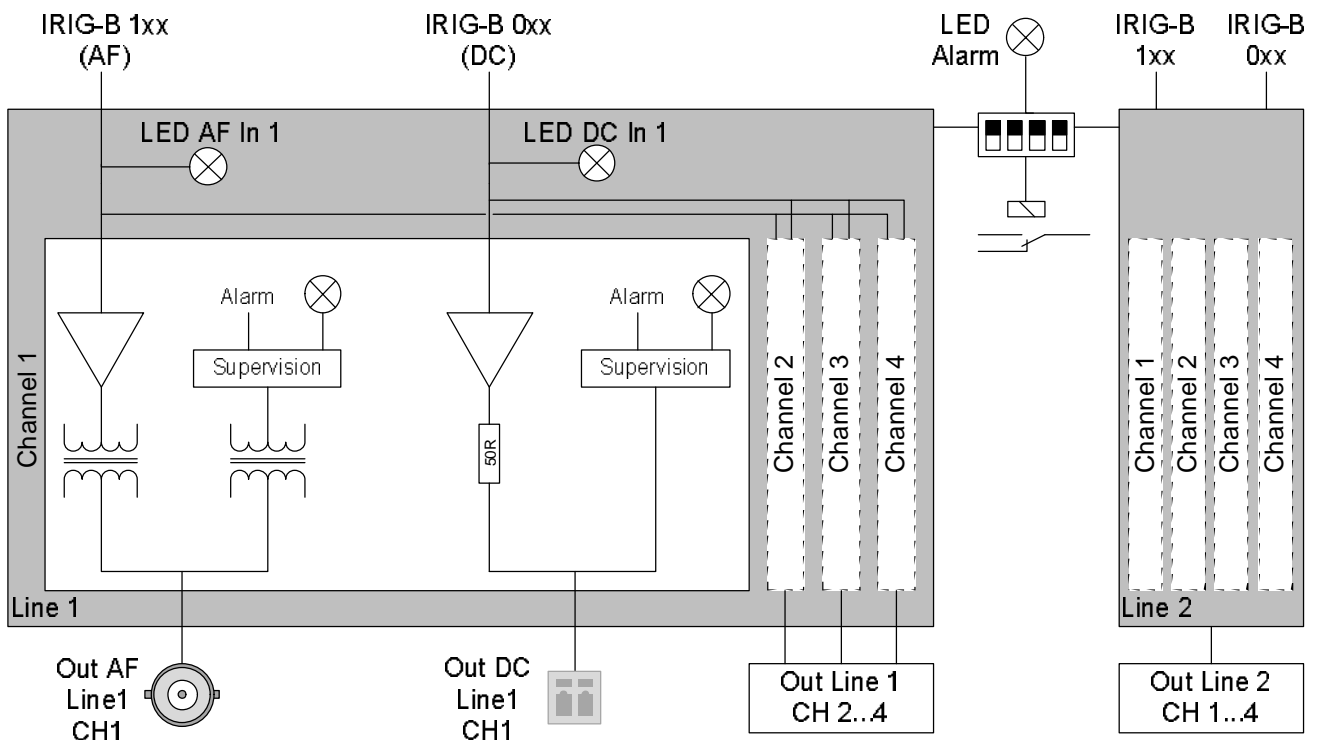

**Important:** The analog and the digital signal distribution can be used at the same time.



**Important:** The digital inputs are only distributed to the digital outputs and the analog inputs are only distributed to the analog outputs. This means, the digital and the analog distribution is completely independent.



**Important:** The 2340.irig-distributor can also be used to distribute impulse signals. For this application the digital in- and outputs are used.



### **3.4.1 Monitoring**

The IRIG distributor measures and monitors the peak of the signal level at each outlet. Should one of the signals drop below a specified threshold, an alarm will be activated.

The threshold for a valid digital signal is fixed at  $2.6V \pm 20\%$ . The threshold for monitoring AF output signals can be adjusted using two DIP switches (see chapter 4.3).

### **3.4.2 Alarms**

An alarm will be activated for each outlet whose signal level drops below the specified monitoring threshold.

At any given time, all activated alarms will be combined into one collective alarm. An alarm LED on the front of the distributor indicates the status of the collective alarm. In the case of an error, the alarm relay will be switched.

With the use of four DIP switches (see chapter 4.3), monitoring can be switched off for each of the four inlets and their corresponding outlets. If an inlet is not in use, the corresponding monitoring switch must be turned off to avoid a permanent error.

### **3.4.3 Display**

An LED on the front of the distributor indicates the status of all input signals. An LED on the back of the device shows the status of each outlet.

The brightness of the digital output LEDs hints at the load connected to the output and at the resulting output voltage. The weaker the glow of the LED, the stronger the load of the output.

## 4 Configuration and Display

### 4.1 Status Indicators: Front

Six LEDs on the front of the device indicate the status of the distributor.

LED		Status	Meaning
power		On	The distributor is receiving power.
		Off	The distributor is not receiving power.
alarm		On	There is at least one active error.
		Off	There are no active errors.
Input line 1	digital	On	Signal is detected.
		Off	No signal is present.
	modulated AF	On	Signal is detected.
		Off	No signal is present.
Input line 2	digital	On	Signal is detected.
		Off	No signal is present.
	modulated AF	On	Signal is detected.
		Off	No signal is present.

### 4.2 Signal LEDs: Back

An LED on the rear of the device indicates the status of each output signal.

Status	Meaning
Off	Outlet is inactive or is below the specified threshold.
On	Signal is detected.

### 4.3 Configuration of the IRIG Distributor

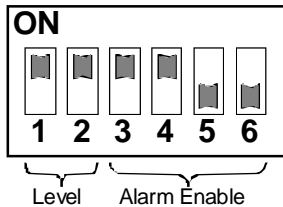

On the rear of the IRIG distributor, there are six DIP switches for configuring the performance of the device.

The first two switches are for setting the monitoring threshold for the AF output signals.

Switches 3–6 can be used to disable monitoring of each individual input signal and its corresponding output.

Switch		Threshold
2	1	[Vpp]
OFF	OFF	1.2V ± 20%
OFF	ON	2.0V ± 20%
ON	OFF	2.8V ± 20%
ON	ON	3.1V ± 20%

Switch	Status	Meaning
3	ON/OFF	Switch monitoring on/off for AF signal, line 1
4	ON/OFF	Switch monitoring on/off for AF signal, line 2
5	ON/OFF	Switch monitoring on/off for D signal, line 1
6	ON/OFF	Switch monitoring on/off for D signal, line 2

## 5 Connections

### Line 1 and DC Power Supply:

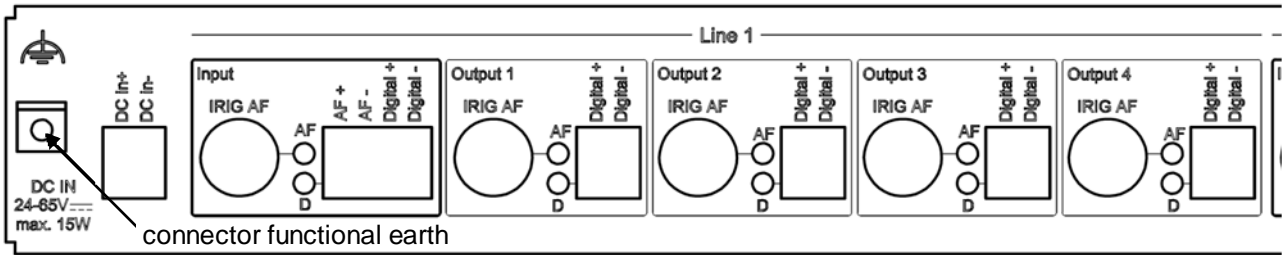

### Line 2 and Alarm Contact, DIP Switches for Configuring Alarms:

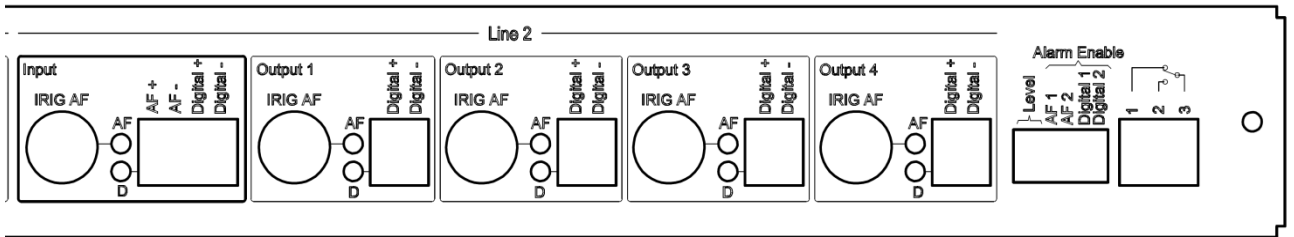

### 5.1 Power Supply

The power plug has the following pin assignment:

Terminal	Description
DC In+	Inlet for external DC power supply, 24–65V
DC In-	Ground connection for external DC power supply

In order to guarantee a safe operation concerning the EMC, the device can optionally be connected to earth using the functional earth connector.

### 5.2 Input

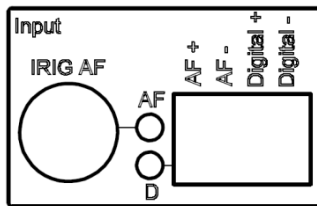

Both inlets for a line are positioned together in an input field for that line. Each one consists of a BNC connector for the AF signal and a spring terminal for the AF and the digital signals.

### 5.3 Output

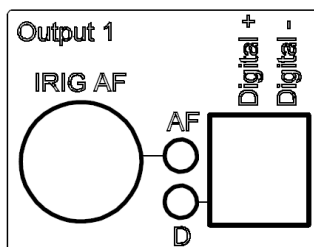

Each of the two lines has four output fields. Each output field carries the corresponding AF and digital signals.

## 5.4 Alarm Relay

The alarm relay contacts are configured as follows:

Terminal	Connection	Description
1	Alarm relay opener	Opens during alarm
2	Alarm relay closer	Closes during alarm
3	Alarm relay changer	Combined tapping

Capacities for the relay contacts are as follows:

- 30W (60 VDC or 1A) or
- 60VA (30 VAC or 1A)

## 5.5 Connection between DTS 4135/4138 and IRIG Distributor

Signal output	Signal type	Max. cable length	Output connection DTS 4135/4138	Input connection DTS 2340
Impulse	Digital, TTL	5 m	RS422 + GND	Linie 1 Input Digital + Linie 1 Input Digital -
	Digital, inverted, TTL	5 m	RS422 - GND	Linie 1 Input Digital + Linie 1 Input Digital -
	Digital, RS422 (differencial)	1000 m	RS422 + RS422 -	Not allowed Not allowed
IRIG	Digital, TTL	5 m	RS422 + GND	Linie 1 Input Digital + Linie 1 Input Digital -
	Digital, inverted, TTL	5 m	RS422 - GND	Linie 1 Input Digital + Linie 1 Input Digital -
	Digital, RS422 (differencial)	1000 m	RS422 + RS422 -	Not allowed Not allowed
	Analog, AM	1000 m	IRIG 1xx (BNC Stecker)	Linie 1/2 Input IRIG AF (BNC connector)
	Analog, AM	1000 m	IRIG 1xx (BNC Stecker)	Linie 1/2 Input AF + Linie 1/2 Input AF -

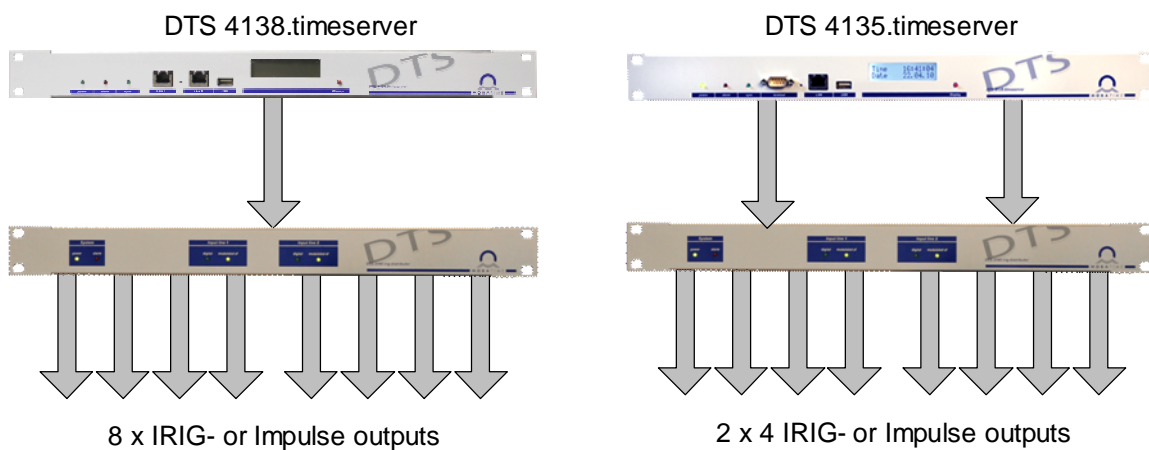

## 6 Technical Data

---

<b>Input Signals</b>	2x IRIG-B 1xx (AF): BNC connector and spring terminal 2x IRIG-B 0xx (D): Spring terminal
<b>Output Signals</b>	4 output channels for each input signal AF: BNC connector D: Spring terminal
<b>Output Impedance</b>	AF: 50Ω @ 1kHz D: 50Ω
<b>Power Supply</b>	24...65VDC
<b>Power Input</b>	< 15W
<b>Operation</b>	4 DIP switches for enabling alarms, one assigned to each of the 4 inlets and their corresponding outlets. If an inlet is not in use, the corresponding monitoring switch must be turned off to avoid a permanent error. 2 DIP switches: Voltage level for the supervision of the AF output signals
<b>Display</b>	Power LED – Front (green) Alarm LED – Front (red) 4x Signal-In LEDs – Front (green) 16x Signal-Out LEDs – Back (green)
<b>Input gauge</b>	The input LEDs glow if at least the following input gauges fit: AF: min. 0.9Vpp max. 5Vpp Digital: min. 2.3V
<b>Input Impedance</b>	AF: 600 Ω Digital: 600 Ω
<b>Output gauge</b>	AF: same as input gauge, min. 2.3 Vpp Digital: 5V (TTL)
<b>Propagation delay</b>	AF: typically 1μs @ 1KHz Digital: typically 100ns
<b>Monitoring</b>	The voltage levels for the output signals are monitored with the following alarm thresholds: Alarm AF: 1.2Vpp ± 20% (SW2 OFF; SW1 OFF) 2.0Vpp ± 20% (SW2 OFF; SW1 ON) 2.8Vpp ± 20% (SW2 ON; SW1 OFF) 3.1Vpp ± 20% (SW2 ON; SW1 ON) Alarm D: 1.9V ± 20%
<b>Alarms</b>	Alarm relay (opener and closer) 30W (60VDC or 1A) 60VA (30VAC or 1A)
<b>Housing</b>	19" stand / 1 HU
<b>Temperature</b>	-5...+50°C

# 7 Dimensions of the IRIG Distributor

The IRIG distributor has the following dimensions in millimeters:

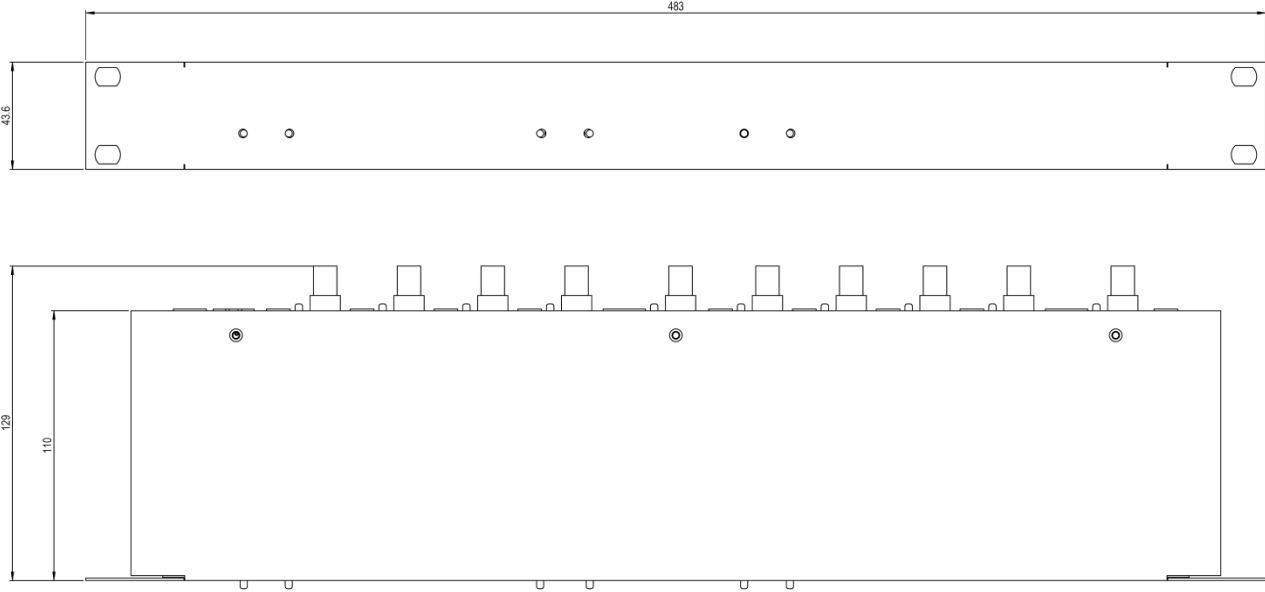



### HEADQUARTERS / PRODUCTION

MOSER-BAER AG  
Spitalstrasse 7, CH-3454 Sumiswald  
Tel. +41 34 432 46 46 / Fax +41 34 432 46 99  
moserbaer@mobatime.com / www.mobatime.com

### SALES WORLDWIDE

MOSER-BAER SA EXPORT DIVISION  
19 ch. du Champ-des-Filles, CH-1228 Plan-les-Ouates  
Tel. +41 22 884 96 11 / Fax + 41 22 884 96 90  
export@mobatime.com / www.mobatime.com

### SALES SWITZERLAND

MOBATIME AG  
Stettbachstrasse 5, CH-8600 Dübendorf  
Tel. +41 44 802 75 75 / Fax +41 44 802 75 65  
info-d@mobatime.ch / www.mobatime.ch

MOBATIME SA  
En Budron H 20, CH-1052 Le Mont-sur-Lausanne  
Tél. +41 21 654 33 50 / Fax +41 21 654 33 69  
info-f@mobatime.ch / www.mobatime.ch

### SALES GERMANY, AUSTRIA

BÜRK MOBATIME GmbH  
Postfach 3760, D-78026 VS-Schwenningen  
Steinkirchring 46, D-78056 VS-Schwenningen  
Tel. +49 7720 8535 0 / Fax +49 7720 8535 11  
buerk@buerk-mobatime.de / www.buerk-mobatime.de